

CONCRETE ACCESSORIES

Sika[®] ARCHITECTURAL
CONCRETE FORMLINERS

CREATIVE IDEAS TAKING SHAPE

BUILDING TRUST





CONTENT

4	Introduction
5	How It Works
6	Application & Reuse
8	Formliner Patterns and Textures
8	Ribbed Designs
14	Stone Designs
18	Block & Brick Designs
21	Fractured Designs
24	Wood Designs
27	Miscellaneous Designs
30	Form Release & Accessories
32	Concrete Admixtures
34	Colored Concrete
36	Installation Guide & Specification Data
43	Technical Services

INTRODUCTION

FOR GENERATIONS, Sika has been proud to promote and advance the use of concrete, and architectural concrete is no exception. Since 1975, Sika has been at the forefront of technology for texturing tilt-up, cast-in-place and precast concrete.

Sika® formliners provide an economical means for adding interest and visual appeal to almost any concrete structure. The desire for architectural concrete continues to grow in both the public and private sectors and the applications for Sika® formliners are limitless.

Sika® formliners attach to almost any forming system or casting bed prior to concrete placement.

Following normal placement practices and curing times, the forming system and liner are stripped leaving an architectural concrete finish. Sika offers a wide array of patterns and textures from which to choose. Patterns are available in a variety of sizes and depths to achieve the best visual effect.



HOW IT WORKS

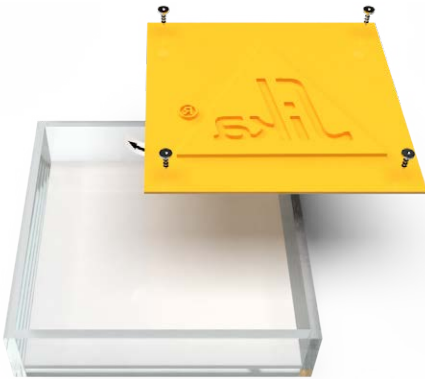

1 Fasten formliner to form using mechanical fasteners, adhesive, or tapes. Ensure the correct side of the liner is facing the formwork (Sika formliners have a tag indicating the formwork side.)



2 Seal all formliner joints, tie holes, and penetrations created by mechanical fasteners using neutral cure silicone sealant.



3 Coat installed formliners using Sika Form Release 8000 to aid in stripping of liners, and improve surface appearance of concrete. Liners are now ready for concrete placement.



4 Once concrete sets, remove finished formliner. **See installation guide for additional information and guidelines (p.36).**



BECAUSE OF ITS STRENGTH AND VERSATILITY, CONCRETE CONTINUES TO GAIN POPULARITY AS THE BUILDING MATERIAL OF CHOICE. MORE AND MORE, OWNERS, DESIGNERS, AND CONTRACTORS REFUSE TO SETTLE FOR PLAIN, UNADORNED CONCRETE.

APPLICATION AND REUSE

Sika® formliners are available in three grades to economically cast an architectural finish in concrete structures of all sizes, types, and budgets. For some projects, it may be more cost effective to use more than one grade. When using multiple grades, it may be necessary to shim the formliner to compensate for thickness variations from grade to grade.

GRADE	MATERIAL TYPE	DESCRIPTION
UNI-CAST®	Rigid Polymer (HIPS)	A single-use formliner ideal for tilt-up panels and cast-in-place construction, requiring cut-outs for doors, windows, utilities, etc.
MULTI-CAST®	Rigid Polymer (ABS)	Intermediate use formliner designed for 2-10 uses under normal job site conditions. Primarily used for cast-in-place applications.
DURA-CAST®	Rigid Polymer (ABS)	Multiple use formliner designed for 10-25 uses under normal job site conditions. Used for cast-in-place and gang forming applications.

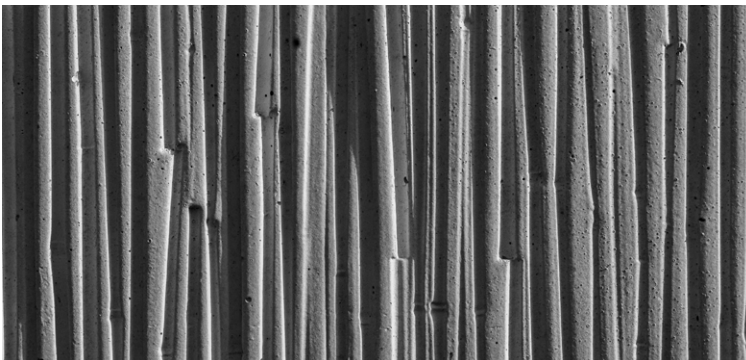



IMPORTANT FACTORS TO REMEMBER

- Pre-construction mock-up is required and must reflect actual job site conditions.
- Some deeper patterns require back-up strips and are noted on the pattern details shown in this catalog. Please refer to the section of this catalog regarding back-up strips for additional information.
- Listed formliner dimensions are nominal. Changes in temperature can cause the liner to expand or contract. Allow for dimensional variations in the design and installation.
- Protect liners from over exposure to direct sunlight.
- Formliners will become more rigid at temperatures below 32°F. Use extra care under these conditions.
- Concrete temperatures in excess of 140°F will adversely affect the material properties of the formliners. Sika does not recommend the use of formliners in these applications.
- Rigid Polymer liners are NOT recommended for precast applications using heated beds.
- Type 3 concrete with accelerators create high heat during cure which could damage Rigid Polymer formliners.
- Rustication strips are recommended at the liner joints that do not blend with the pattern.
- Although UNI-CAST formliners do not require a release agent, Sika® Form Release 8000 is highly recommended to enhance the appearance of the concrete.
- Use one concrete supplier for uniformity of color and texture.
- Place concrete with an elephant trunk to minimize aggregate segregation.
- Vibrate concrete to eliminate lift lines and minimize air voids.
- Clean the liner between castings with a mild detergent and scrub brush.
- Consult Sika St. Louis for further specification information.
- See ACI 303R-04 “Guide to Cast-In-Place Architectural Concrete Practice” for further recommendations in design and use.

FORMLINER PATTERNS & TEXTURES

Sika® formliners are available in a variety of patterns and textures and most are offered in at least three different grades. Please consult Sika St. Louis to determine the most suitable liner for your application and forming technique.

Not all patterns are shown in this catalog. Call Sika US for additional pattern details or if you would like us to create a custom pattern or design.

Trapezoidal and Fractured Rib Designs can be used horizontally in Tilt-up and Precast applications. **Ribbed patterns should only be used vertically in Cast-in-place applications.**



This symbol indicates patterns recommending back-up strips. Please refer to the section of this catalog regarding back-up strips for additional information. **Not all patterns are available in all grades.**

RIBBED DESIGNS



Sheet size	Shape	Available in
3'-11.5" x 9'-11"	Trapezoid	<input checked="" type="checkbox"/> UNI-CAST® <input checked="" type="checkbox"/> MULTI-CAST® <input type="checkbox"/> DURA-CAST®

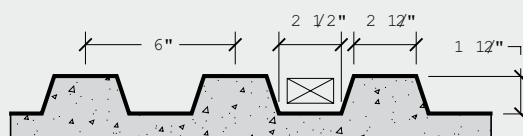

Sheet size	Shape	Available in
3'-11.75" x 10'	Trapezoid	<input checked="" type="checkbox"/> UNI-CAST® <input checked="" type="checkbox"/> MULTI-CAST® <input checked="" type="checkbox"/> DURA-CAST®

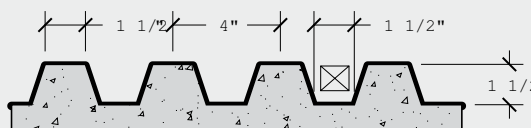

RIBBED DESIGNS CONT'D



Item # 304

Sheet size	Shape	Available in
4' x 10'	Trapezoid	<input checked="" type="checkbox"/> UNI-CAST® <input checked="" type="checkbox"/> MULTI-CAST® <input checked="" type="checkbox"/> DURA-CAST®

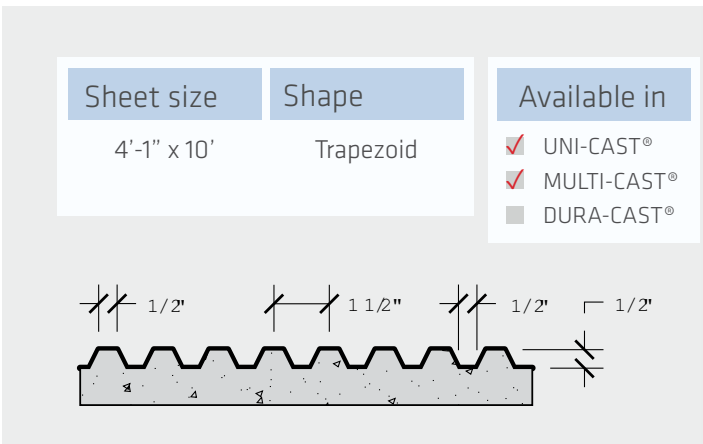
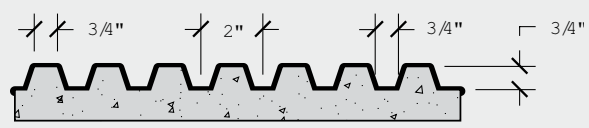

Sheet size	Shape	Available in
4'-1" x 10'	Trapezoid	<input checked="" type="checkbox"/> UNI-CAST® <input checked="" type="checkbox"/> MULTI-CAST® <input type="checkbox"/> DURA-CAST®

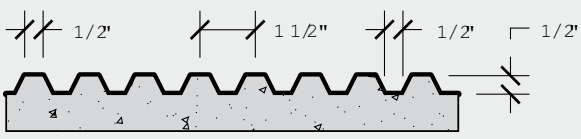

Item # 305



Item # 308

Sheet size	Shape	Available in
4' x 10'	Trapezoid	<input checked="" type="checkbox"/> UNI-CAST® <input checked="" type="checkbox"/> MULTI-CAST® <input type="checkbox"/> DURA-CAST®

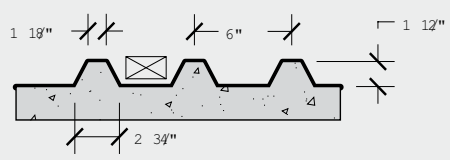

RIBBED DESIGNS CONT'D

Sheet size	Shape
4' x 10'	Random reveal

Available in
<input checked="" type="checkbox"/> UNI-CAST®
<input checked="" type="checkbox"/> MULTI-CAST®
<input type="checkbox"/> DURA-CAST®

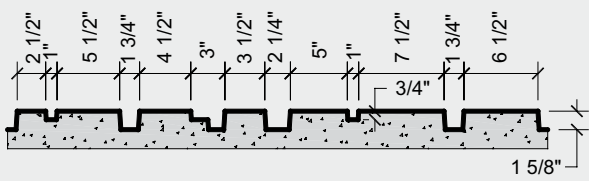

Item # 309



Item # 310

Sheet size	Shape
4' x 10'	Trapezoid

Available in
<input checked="" type="checkbox"/> UNI-CAST®
<input checked="" type="checkbox"/> MULTI-CAST®
<input type="checkbox"/> DURA-CAST®

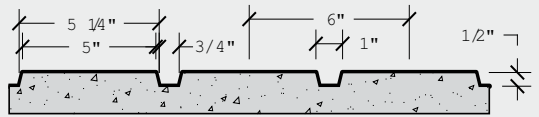

Sheet size	Shape
3'-11.5" x 10'	Trapezoid

Available in
<input checked="" type="checkbox"/> UNI-CAST®
<input checked="" type="checkbox"/> MULTI-CAST®
<input type="checkbox"/> DURA-CAST®

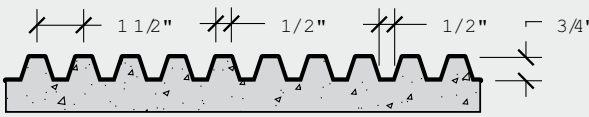

Item # 312

RIBBED DESIGNS CONT'D

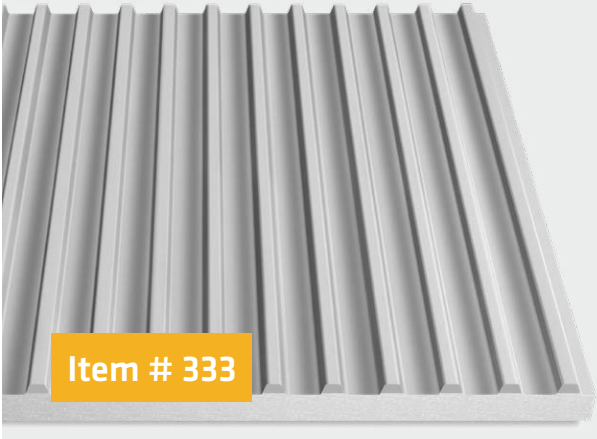

Sheet size	Shape	Available in
4' x 10'	Trapezoid	<input checked="" type="checkbox"/> UNI-CAST® <input checked="" type="checkbox"/> MULTI-CAST® <input type="checkbox"/> DURA-CAST®

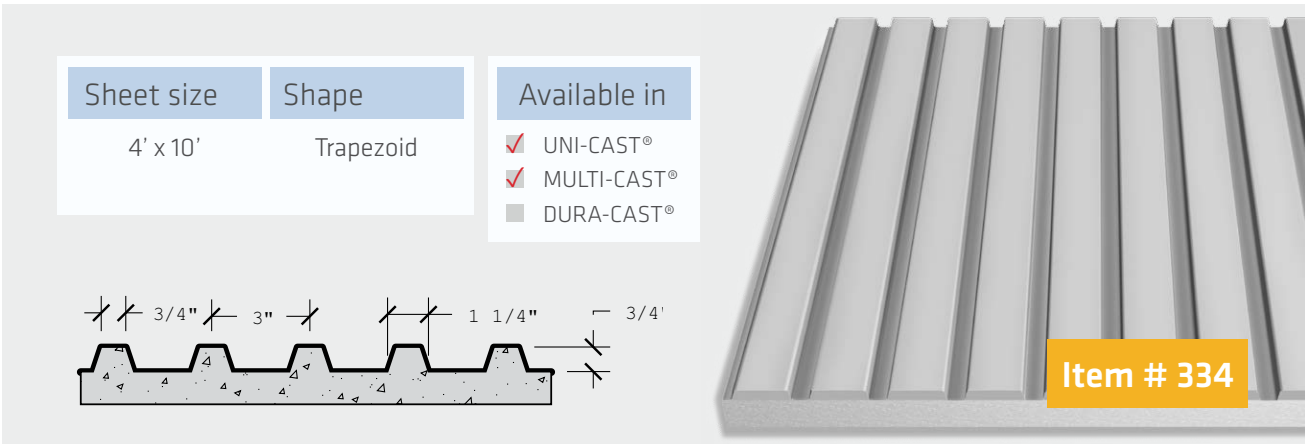
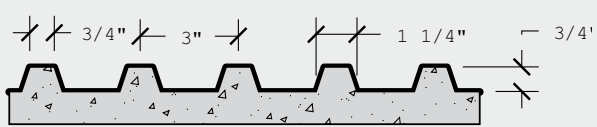

Sheet size	Shape	Available in
4' x 10'	Trapezoid	<input checked="" type="checkbox"/> UNI-CAST® <input checked="" type="checkbox"/> MULTI-CAST® <input type="checkbox"/> DURA-CAST®

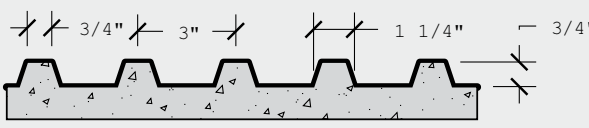

Sheet size	Shape	Available in
4' x 10'	Trapezoid	<input checked="" type="checkbox"/> UNI-CAST® <input checked="" type="checkbox"/> MULTI-CAST® <input type="checkbox"/> DURA-CAST®

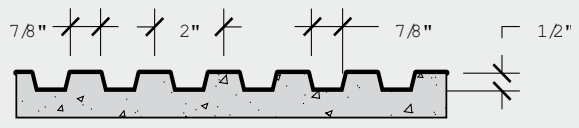

RIBBED DESIGNS CONT'D

Sheet size	Shape	Available in
3'-11 3/4" x 9'-10"	Random parallel reveals	<input checked="" type="checkbox"/> UNI-CAST® <input checked="" type="checkbox"/> MULTI-CAST® <input checked="" type="checkbox"/> DURA-CAST®

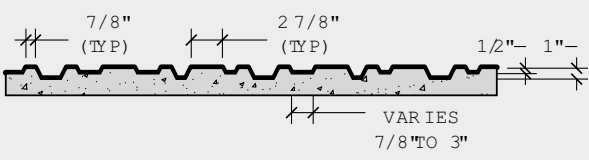

Item # 353

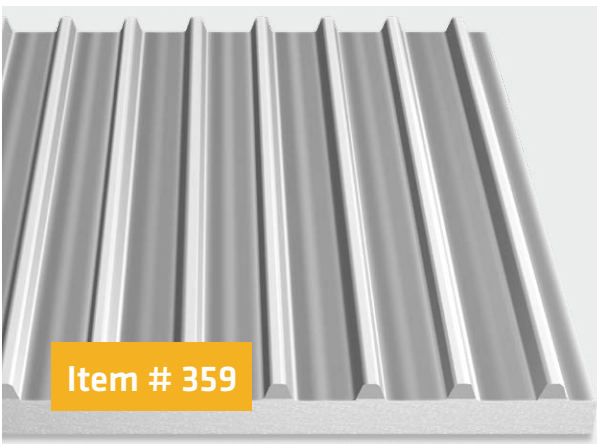

Item # 359

Sheet size	Shape	Available in
4' x 9'-6"	Trapezoid	<input checked="" type="checkbox"/> UNI-CAST® <input checked="" type="checkbox"/> MULTI-CAST® <input type="checkbox"/> DURA-CAST®

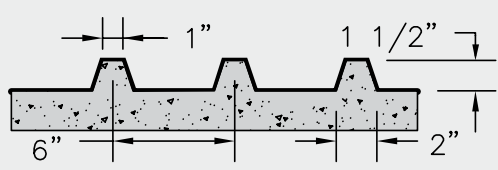

Sheet size	Shape	Available in
4' x 9'-10"	Random reveal	<input checked="" type="checkbox"/> UNI-CAST® <input checked="" type="checkbox"/> MULTI-CAST® <input type="checkbox"/> DURA-CAST®

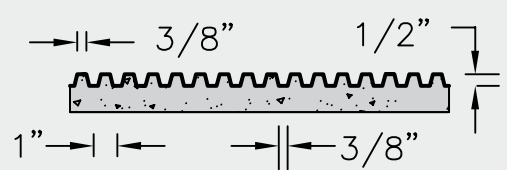

Item # 361

RIBBED DESIGNS CONT'D

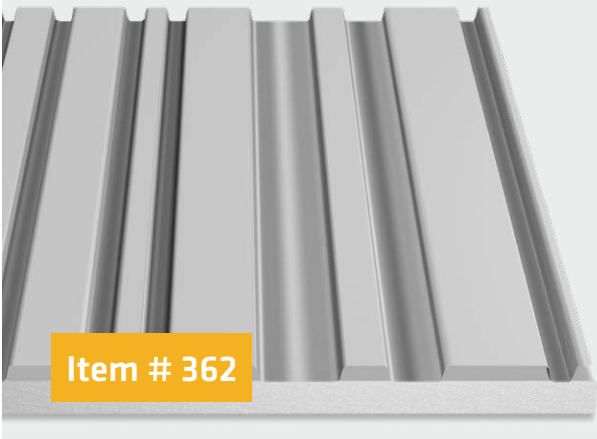

Item # 362

Sheet size	Shape	Available in
4' x 9'-10"	Random reveal AZ D.O.T	<input checked="" type="checkbox"/> UNI-CAST® <input checked="" type="checkbox"/> MULTI-CAST® <input type="checkbox"/> DURA-CAST®

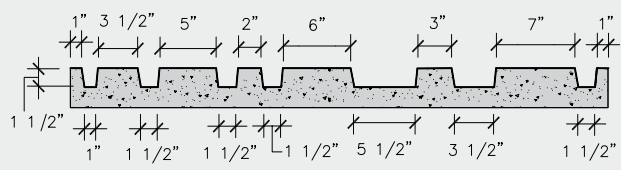

Sheet size	Shape	Available in
4' x 10'	Ripped rope	<input checked="" type="checkbox"/> UNI-CAST® <input checked="" type="checkbox"/> MULTI-CAST® <input type="checkbox"/> DURA-CAST®



Item # 374

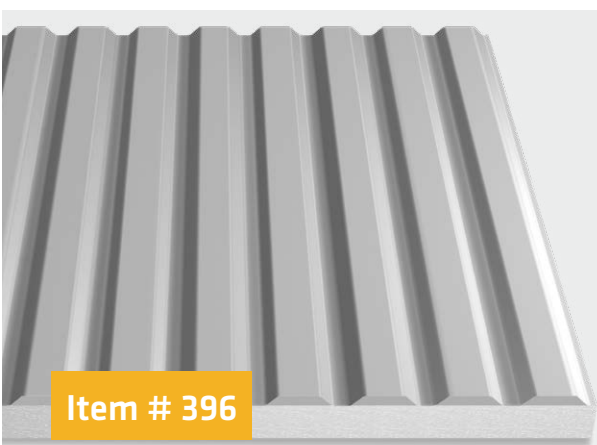

Item # 396

Sheet size	Shape	Available in
4'- 1/8" x 10'	Trapezoid	<input checked="" type="checkbox"/> UNI-CAST® <input checked="" type="checkbox"/> MULTI-CAST® <input type="checkbox"/> DURA-CAST®

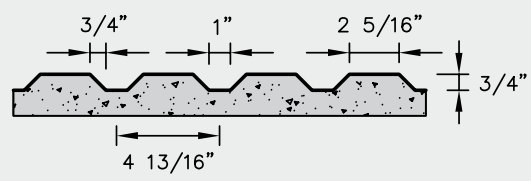

STONE DESIGNS



Item # 328

Available in	Sheet size	Shape
<ul style="list-style-type: none"> ✓ UNI-CAST® ✓ MULTI-CAST® ■ DURA-CAST® 	9'-10 3/4" x 3'-11 1/2"	Drystack random stone
Relief: Varies 1/2" - 1-1/2"		

Sheet size	Shape	Available in
4' x 10'	12" x 24" Running bond ashlar	<ul style="list-style-type: none"> ✓ UNI-CAST® ✓ MULTI-CAST® ■ DURA-CAST®
Relief: Varies 1-1/2" maximum		



Item # 329



Item # 330

Available in	Sheet size	Shape
<ul style="list-style-type: none"> ✓ UNI-CAST® ✓ MULTI-CAST® ✓ DURA-CAST® 	4' x 10'	Ashlar stone
Relief: Varies 1/2" - 1-1/4"		

STONE DESIGNS CONT'D

Sheet size	Shape
3'-10 3/4" x 7'-10 3/4"	Sierra drystack

Relief: Varies 1-1/2" maximum

Available in	
<input type="checkbox"/>	UNI-CAST®
<input checked="" type="checkbox"/>	MULTI-CAST®
<input type="checkbox"/>	DURA-CAST®



Item # 439

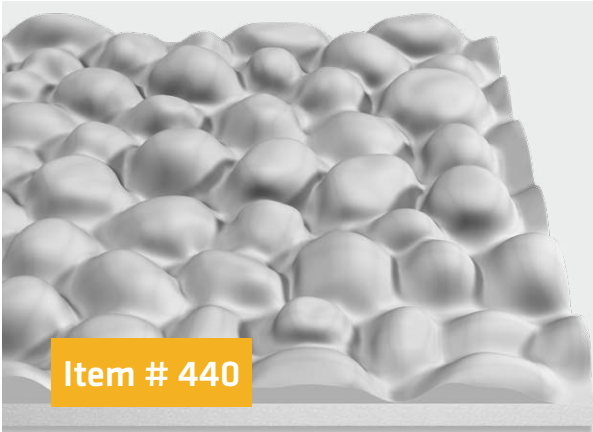

Item # 440

Sheet size	Shape
10'-1" x 4'-1/4"	River rock

Relief: Varies 2" maximum

Available in	
<input checked="" type="checkbox"/>	UNI-CAST®
<input checked="" type="checkbox"/>	MULTI-CAST®
<input type="checkbox"/>	DURA-CAST®

Sheet size	Shape
8' x 4'	Spring creek stone

Relief: 3/4" maximum, 1/2" - 3/4" avg

Available in	
<input checked="" type="checkbox"/>	UNI-CAST®
<input checked="" type="checkbox"/>	MULTI-CAST®
<input type="checkbox"/>	DURA-CAST®



Item # 454

STONE DESIGNS CONT'D



Item # 460

Sheet size	Shape	Available in
10'-1" x 4'-1/2"	Ashlar cut stone	<input checked="" type="checkbox"/> UNI-CAST® <input checked="" type="checkbox"/> MULTI-CAST® <input type="checkbox"/> DURA-CAST®
Relief: 1-1/2" maximum		

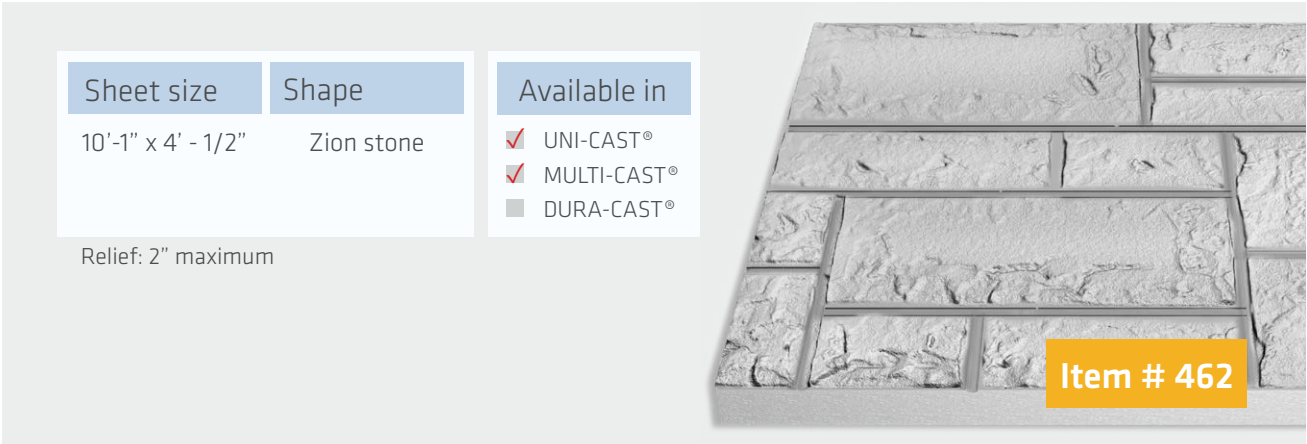

Item # 462

Sheet size	Shape	Available in
10'-1" x 4' - 1/2"	Zion stone	<input checked="" type="checkbox"/> UNI-CAST® <input checked="" type="checkbox"/> MULTI-CAST® <input type="checkbox"/> DURA-CAST®
Relief: 2" maximum		



Item # 468

Sheet size	Shape	Available in
10'- 1/2" x 3'-3 1/4"	Willow wall stone	<input checked="" type="checkbox"/> UNI-CAST® <input checked="" type="checkbox"/> MULTI-CAST® <input type="checkbox"/> DURA-CAST®
Relief: 2" maximum		

STONE DESIGNS CONT'D

Sheet size	Shape
10' - 3/4" x 4' - 1/4"	Random cut stone 16"

Relief: Varies 1.5" maximum

Available in
<input checked="" type="checkbox"/> UNI-CAST®
<input checked="" type="checkbox"/> MULTI-CAST®
<input type="checkbox"/> DURA-CAST®



Item # 472



Item # 476

Sheet size	Shape
9' x 3'-3/8"	Running bond cut stone 18"

Relief: 1-1/4" maximum

*Image shows two layers of formliner

Available in
<input checked="" type="checkbox"/> UNI-CAST®
<input checked="" type="checkbox"/> MULTI-CAST®
<input type="checkbox"/> DURA-CAST®

Sheet size	Shape
10' x 4'	Meramec DryStack stone

Relief: 1-1/8" maximum

Available in
<input checked="" type="checkbox"/> UNI-CAST®
<input checked="" type="checkbox"/> MULTI-CAST®
<input type="checkbox"/> DURA-CAST®



Item # 477

BLOCK AND BRICK DESIGNS



Item # 303

Sheet size

9'-5 1/2" x
3'-11 3/4"

Shape

Smooth face
block

Available in

- ✓ UNI-CAST®
- ✓ MULTI-CAST®
- DURA-CAST®

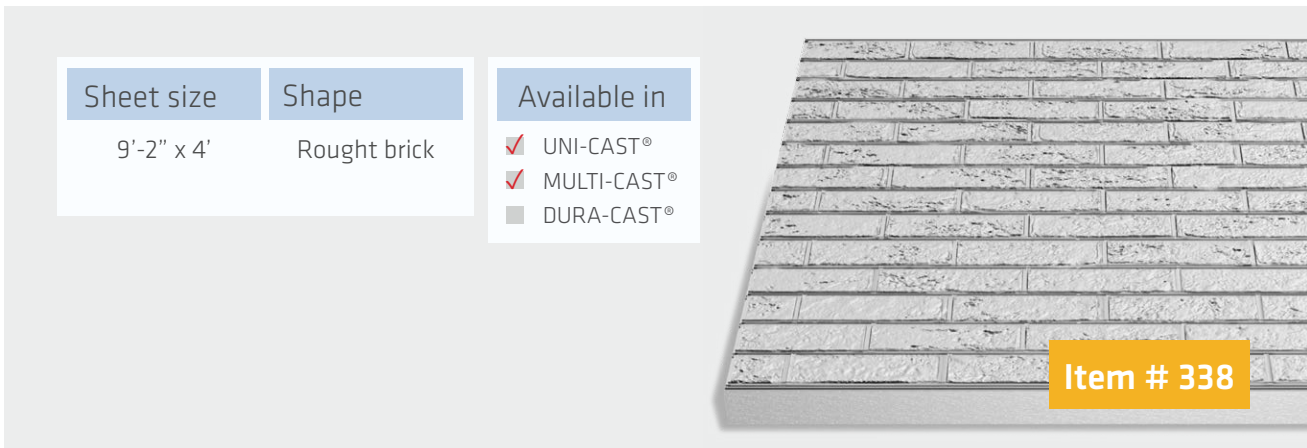

Item # 338

Sheet size

9'-2" x 4'

Shape

Rough brick

Available in

- ✓ UNI-CAST®
- ✓ MULTI-CAST®
- DURA-CAST®



Item # 341

Sheet size

10' 3/8" x 4'

Shape

8" square split
face block

Available in

- ✓ UNI-CAST®
- ✓ MULTI-CAST®
- DURA-CAST®

BLOCK AND BRICK DESIGNS CONT'D

Sheet size	Shape	Available in
9'-4" x 4'	8"x16" split face block	<input checked="" type="checkbox"/> UNI-CAST® <input checked="" type="checkbox"/> MULTI-CAST® <input type="checkbox"/> DURA-CAST®



Sheet size	Shape	Available in
10' x 4'	6"x12" smooth face block	<input checked="" type="checkbox"/> UNI-CAST® <input checked="" type="checkbox"/> MULTI-CAST® <input type="checkbox"/> DURA-CAST®

Sheet size	Shape	Available in
9'-4" x 4"	8"x16" cinder block	<input checked="" type="checkbox"/> UNI-CAST® <input checked="" type="checkbox"/> MULTI-CAST® <input type="checkbox"/> DURA-CAST®



BLOCK AND BRICK DESIGNS CONT'D



Sheet size	Shape	Available in
10' x 4'	Smooth face brick	<input checked="" type="checkbox"/> UNI-CAST® <input checked="" type="checkbox"/> MULTI-CAST® <input type="checkbox"/> DURA-CAST®

Item # 403

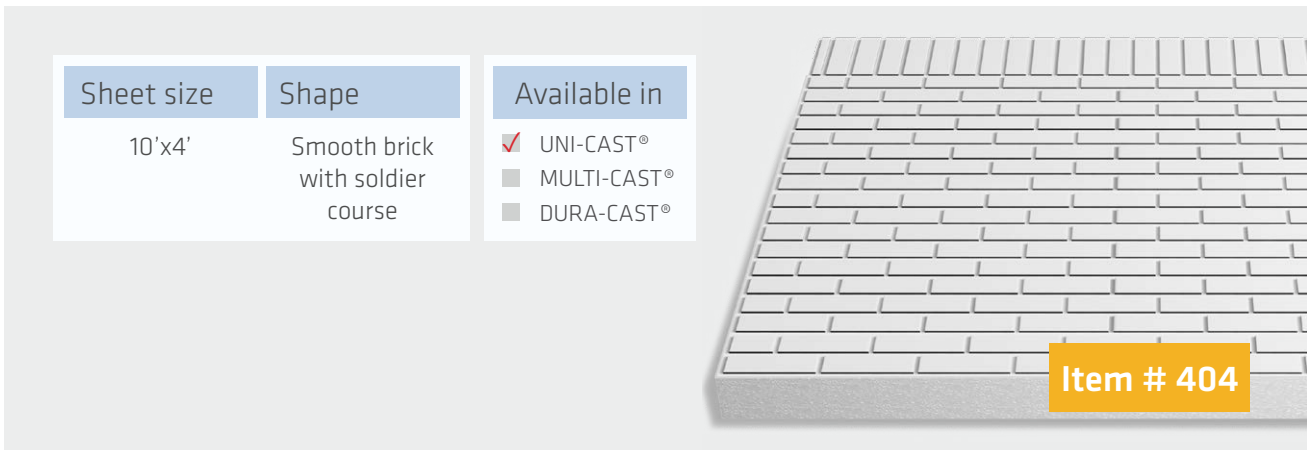

Sheet size	Shape	Available in
10'x4'	Smooth brick with soldier course	<input checked="" type="checkbox"/> UNI-CAST® <input type="checkbox"/> MULTI-CAST® <input type="checkbox"/> DURA-CAST®

Item # 404



Sheet size	Shape	Available in
10' x 4'	Smooth face utility brick	<input checked="" type="checkbox"/> UNI-CAST® <input checked="" type="checkbox"/> MULTI-CAST® <input type="checkbox"/> DURA-CAST®

Item # 453

FRACTURED DESIGNS



Item # 347

Sheet size

3'-11 1/2" x 9' x
10"

Shape

Trapezoid with
aggregate face

Available in

- ✓ UNI-CAST®
- ✓ MULTI-CAST®
- DURA-CAST®

Optional closed or open ends, open end sheets are 9-9"

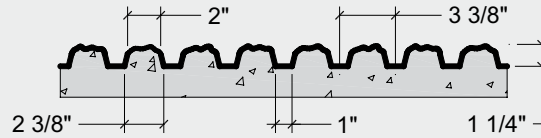

Sheet size

3'-11 1/4" x 10'

Shape

Fractured rib

Available in

- ✓ UNI-CAST®
- ✓ MULTI-CAST®
- ✓ DURA-CAST®

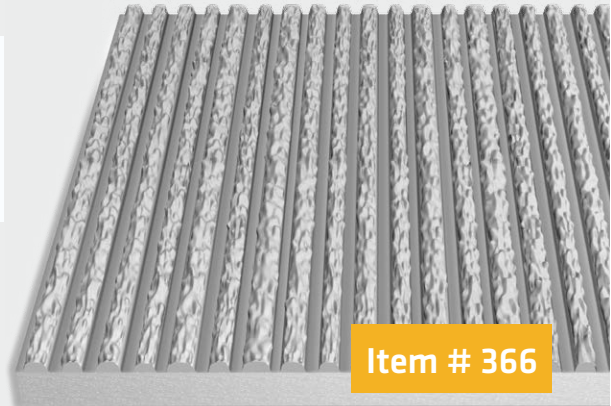
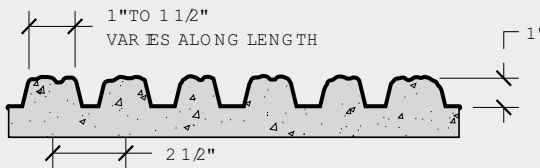

Item # 366

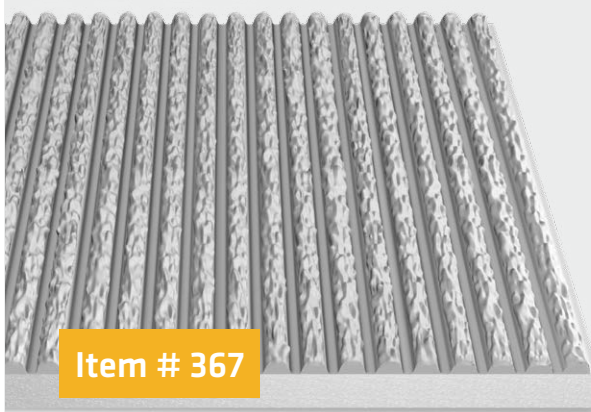

Item # 367

Sheet size

4' x 10'

Shape

Fractured rib
VA D.O.T

Available in

- ✓ UNI-CAST®
- ✓ MULTI-CAST®
- ✓ DURA-CAST®

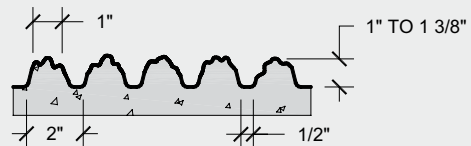

FRACTURED DESIGNS CONT'D

Sheet size	Shape	Available in
4'-1" x 10'	Trapezoid with aggregate face	<input checked="" type="checkbox"/> UNI-CAST® <input checked="" type="checkbox"/> MULTI-CAST® <input type="checkbox"/> DURA-CAST®

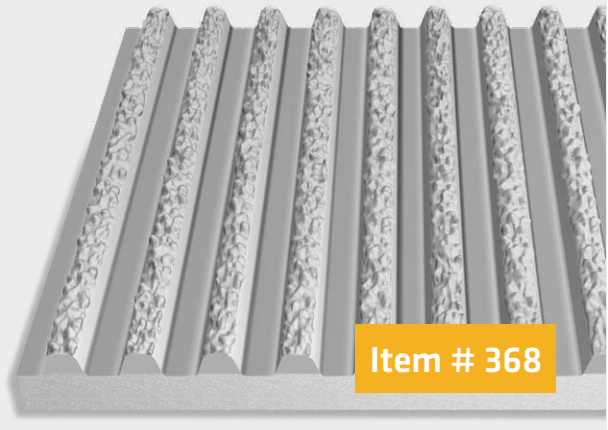
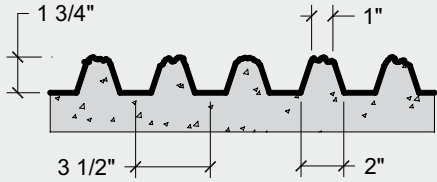

Item # 368



Item # 369

Sheet size	Shape	Available in
4' x 10'	Trapezoid with aggregate face	<input checked="" type="checkbox"/> UNI-CAST® <input checked="" type="checkbox"/> MULTI-CAST® <input type="checkbox"/> DURA-CAST®

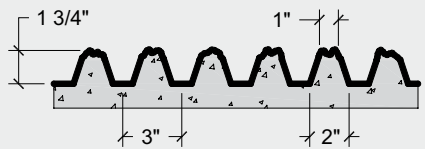

Sheet size	Shape	Available in
4' x 10'	Fractured fin	<input checked="" type="checkbox"/> UNI-CAST® <input checked="" type="checkbox"/> MULTI-CAST® <input type="checkbox"/> DURA-CAST®

Available with ribs rotated 45°

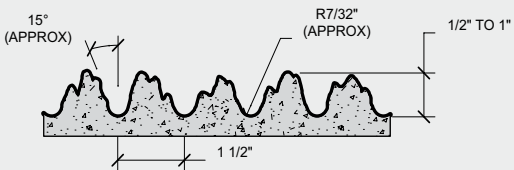

Item # 373

FRACTURED DESIGNS CONT'D



Item # 376

Sheet size

4' x 10'

Shape

Fractured
granite

Available in

- UNI-CAST®
- MULTI-CAST®
- DURA-CAST®

Optional closed or open ends, open end sheets are 9'-9"

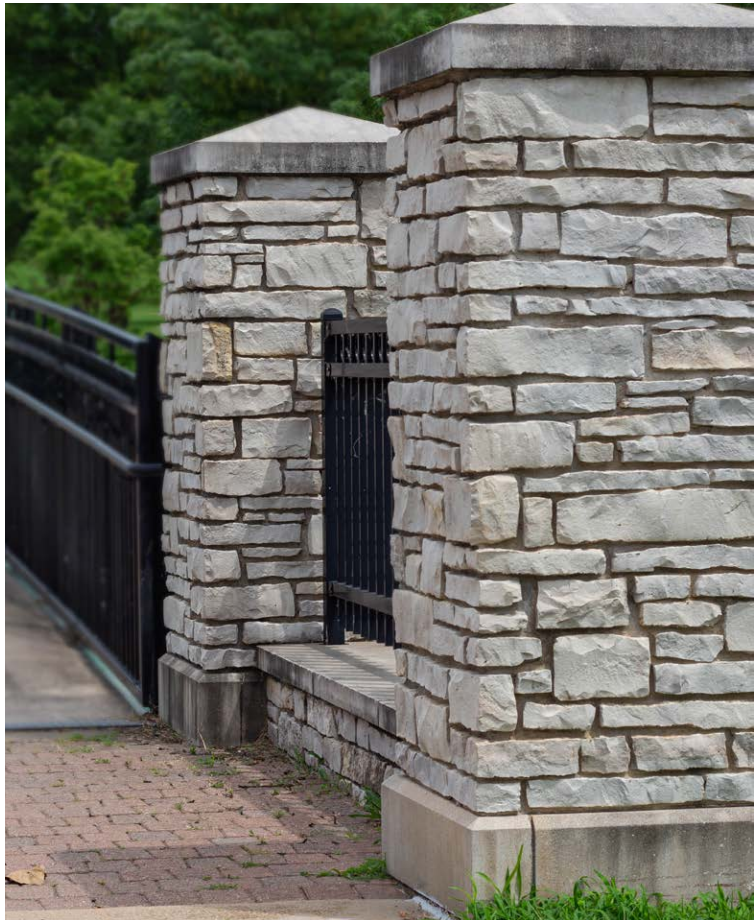

Fractured

WOOD DESIGNS

Sheet size

4' x 9'-10"

Shape

Weathered
random boards

Available in

- ✓ UNI-CAST®
- ✓ MULTI-CAST®
- ✓ DURA-CAST®

Optional closed or open ends, open end sheets are 9-9"

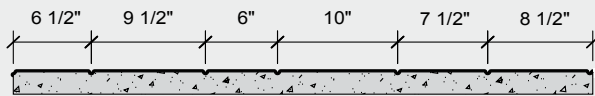

Item # 344

Sheet size

4' x 9'-10"

Shape

Weathered
boards

Available in

- ✓ UNI-CAST®
- ✓ MULTI-CAST®
- ✓ DURA-CAST®

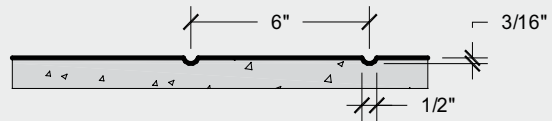

Item # 346

Sheet size

3'-11 3/4" x
8'-11"

Shape

Rough southern
yellow pine

Available in

- ✓ UNI-CAST®
- ✓ MULTI-CAST®
- DURA-CAST®

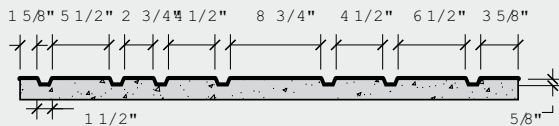

Item # 351

WOOD DESIGNS CONT'D



Item # 363

Sheet size	Shape	Available in
3'-11 3/4" x 8'-11"	Weathered tongue & groove	<input checked="" type="checkbox"/> UNI-CAST® <input checked="" type="checkbox"/> MULTI-CAST® <input checked="" type="checkbox"/> DURA-CAST®

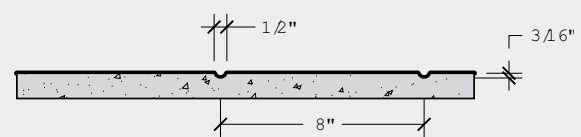

Sheet size	Shape	Available in
4' x 10'	Random pacific lap	<input checked="" type="checkbox"/> UNI-CAST® <input checked="" type="checkbox"/> MULTI-CAST® <input type="checkbox"/> DURA-CAST®

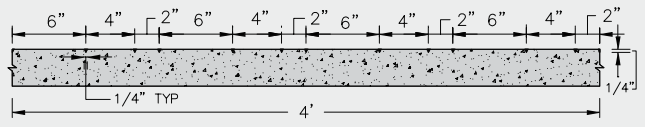

Item # 434



Item # 463

Sheet size	Shape	Available in
4' x 10'	Weathered wood grain	<input checked="" type="checkbox"/> UNI-CAST® <input checked="" type="checkbox"/> MULTI-CAST® <input checked="" type="checkbox"/> DURA-CAST®

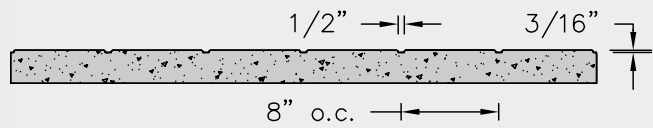

Wood

WOOD DESIGNS CONT'D

Sheet size	Shape	Available in
4' x 10'	Random hi/low cedar board	<input checked="" type="checkbox"/> UNI-CAST® <input checked="" type="checkbox"/> MULTI-CAST® <input type="checkbox"/> DURA-CAST®

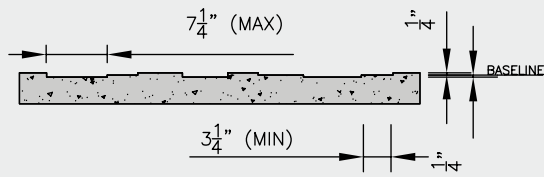

Item # 465

Wood



MISCELLANEOUS DESIGNS



Sheet size	Shape	Available in
4' x 9'-10"	Smooth finish	<input checked="" type="checkbox"/> UNI-CAST® <input checked="" type="checkbox"/> MULTI-CAST® <input checked="" type="checkbox"/> DURA-CAST®

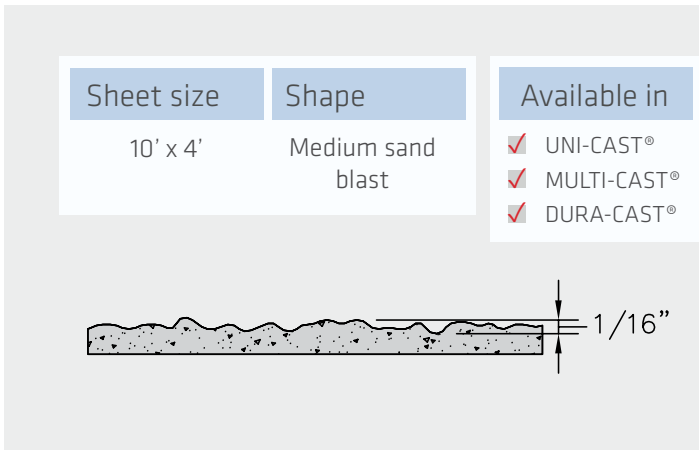

Sheet size	Shape	Available in
10' x 4'	Medium sand blast	<input checked="" type="checkbox"/> UNI-CAST® <input checked="" type="checkbox"/> MULTI-CAST® <input checked="" type="checkbox"/> DURA-CAST®



Sheet size	Shape	Available in
4' x 10'	Light sand blast	<input checked="" type="checkbox"/> UNI-CAST® <input checked="" type="checkbox"/> MULTI-CAST® <input checked="" type="checkbox"/> DURA-CAST®

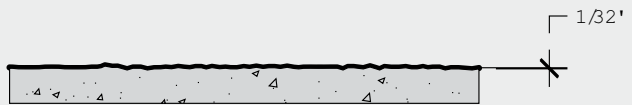

Misc.

MISCELLANEOUS DESIGNS CONT'D

Sheet size	Shape	Available in
4' x 10'	Striated sinusoidal wave	<input checked="" type="checkbox"/> UNI-CAST® <input checked="" type="checkbox"/> MULTI-CAST® <input checked="" type="checkbox"/> DURA-CAST®

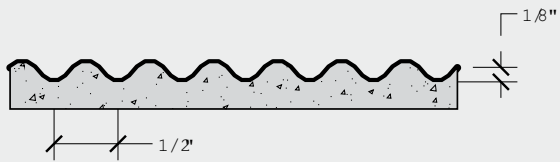

Item # 354

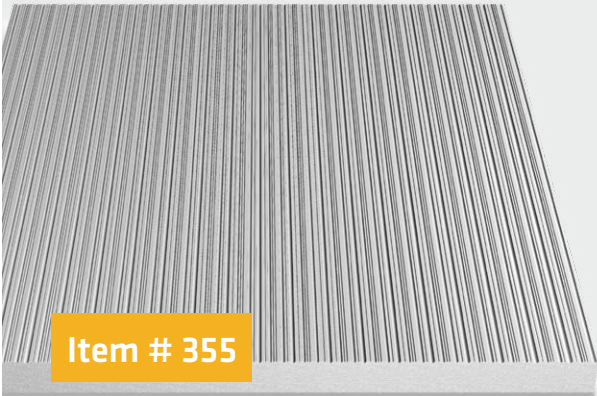

Sheet size	Shape	Available in
4' x 10'	Random striated wave	<input checked="" type="checkbox"/> UNI-CAST® <input checked="" type="checkbox"/> MULTI-CAST® <input type="checkbox"/> DURA-CAST®

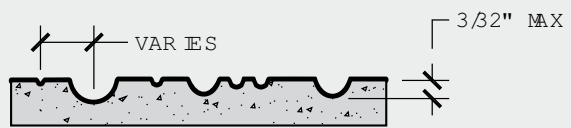

Item # 355

Sheet size	Shape	Available in
10' x 4'	Shiplap	<input checked="" type="checkbox"/> UNI-CAST® <input checked="" type="checkbox"/> MULTI-CAST® <input checked="" type="checkbox"/> DURA-CAST®

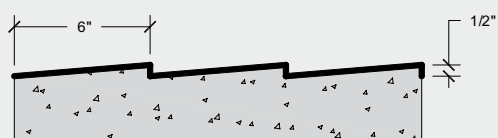

Item # 357

Misc.

MISCELLANEOUS DESIGNS CONT'D



Sheet size	Shape	Available in
4' x 10'	Riverbed aggregate	<input checked="" type="checkbox"/> UNI-CAST® <input checked="" type="checkbox"/> MULTI-CAST® <input checked="" type="checkbox"/> DURA-CAST®

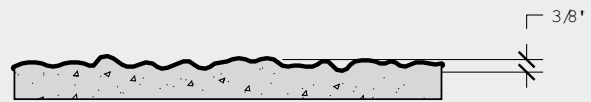

Sheet size	Shape	Available in
4' x 10'	Flamed granite	<input checked="" type="checkbox"/> UNI-CAST® <input checked="" type="checkbox"/> MULTI-CAST® <input checked="" type="checkbox"/> DURA-CAST®

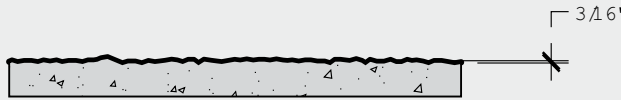

Sheet size	Shape	Available in
4' x 10'	Flagstone	<input checked="" type="checkbox"/> UNI-CAST® <input checked="" type="checkbox"/> MULTI-CAST® <input checked="" type="checkbox"/> DURA-CAST®

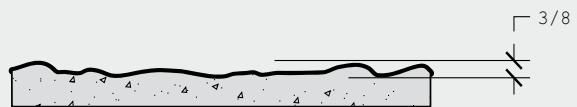

Misc.

FORM RELEASE & ACCESSORIES

SIKA® FORM RELEASE 8000

SIKA® FORM RELEASE 8000 is a VOC compliant, petroleum based chemical release for concrete forms that effectively prevents bonding of concrete to plastic, steel, aluminum, treated paper forms, and plywood.

Its use is recommended with all reusable Sika® plastic formliners.

ADVANTAGES

- Will not stain or discolor concrete
- Leaves concrete ready for curing, sealing, or painting
- Minimizes form clean-up
- Waterproofs plywood and helps prevent deterioration and corrosion of steel

COVERAGE

- High coverage rate
- Steel, aluminum, plastic, high density plywood... 2000-2500ft²/US gal.
- Rough sawn lumber, striated plywood... 800-1000 ft²/US gal.

TECHNICAL

- Contains no diesel fuel or kerosene
- Red label not required

BACK-UP STRIPS

Foam or wood back-up strips provide additional support to prevent deflection of the formliner due to form pressures. Back-up strip recommendations are designated in pattern details.

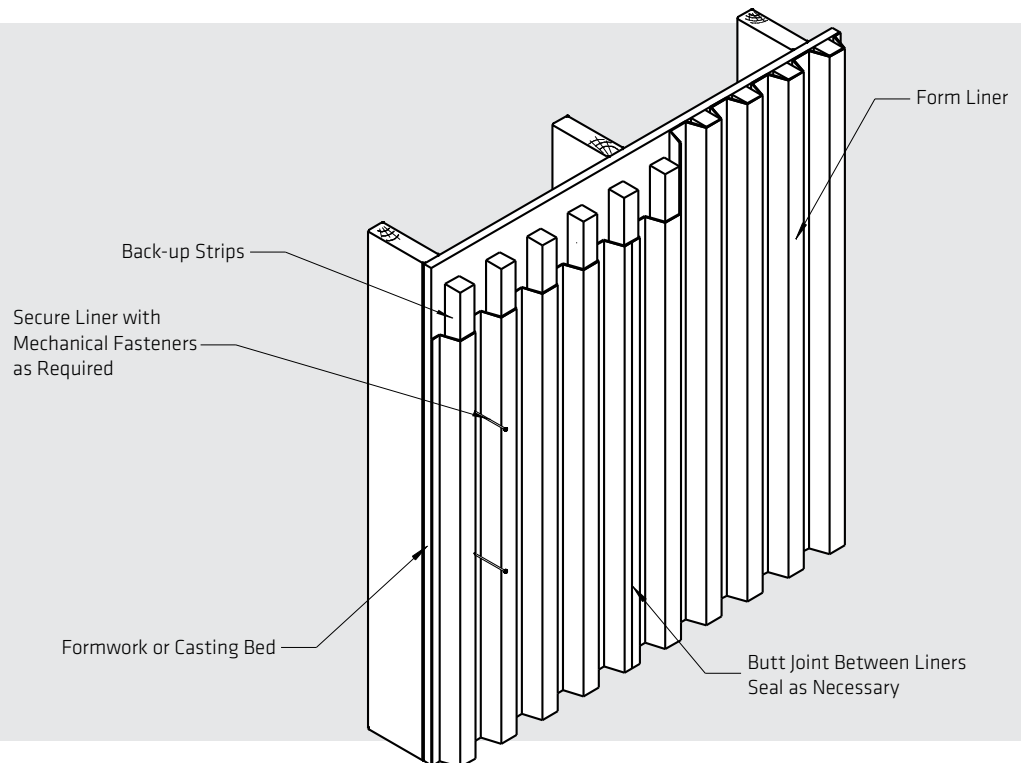

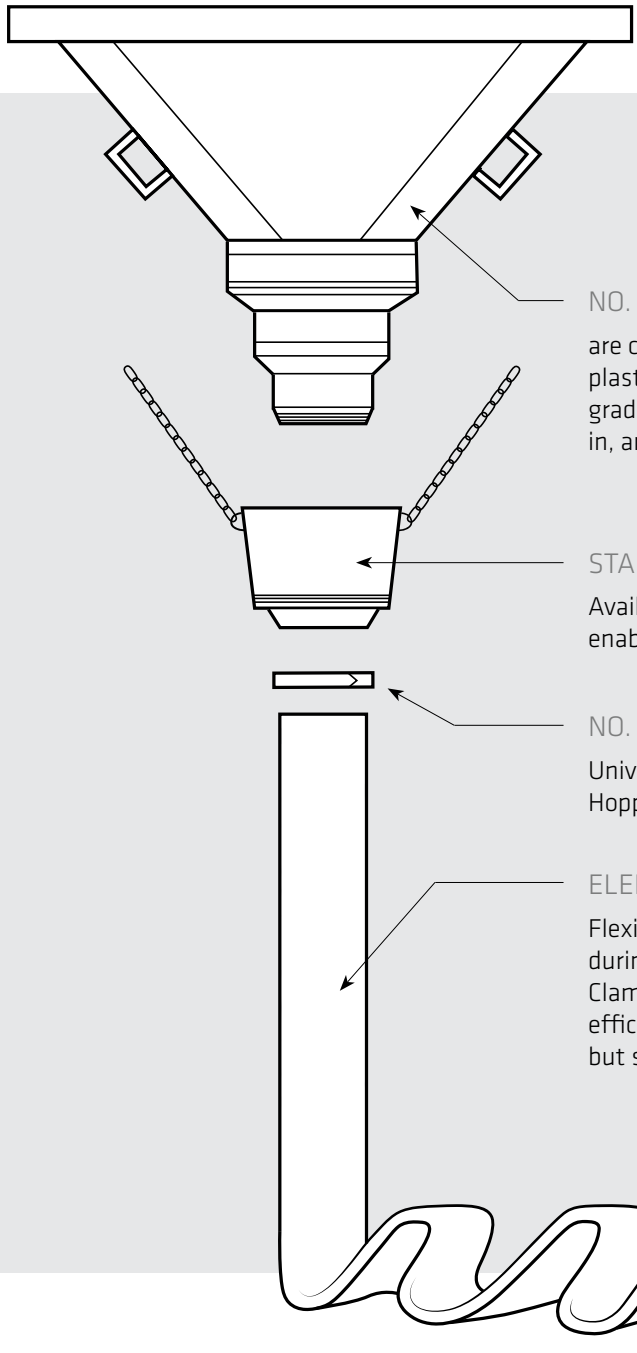

NO. 484 3-IN-1 HOPPER

are constructed from highly durable, yet lightweight plastic for easy handling. The intake is 36 in² with a graduated discharge that can be trimmed to fit 6 in, 8 in, and 12 in diameter Elephant Trunks.

STAINLESS STEEL COLLAR

Available for 8" and 12" diameter Elephant Trunk and enable a quick release from the Hopper.

NO. 690 STEEL BANDING CLAMP

Universally sized for securing any Elephant Trunk to Hoppers or Collars.

ELEPHANT TRUNK

Flexible PVC chute used to confine and direct concrete during placement in forms. Hoppers, Collars, and Clamps are convenient accessories for safely and efficiently funnelling concrete. Shipped in 50 ft rolls, but should not be used in lengths greater than 25 ft.

CONCRETE ADMIXTURES

Concrete design begins with the proper proportioning of cement, water, and aggregate.

Design of concrete, however, is optimized for value, workability, and performance with the addition of chemical and mineral admixtures. The foundation of Sika was built in 1910 with its first concrete admixture - it is no surprise that Sika is also the world's largest and most trusted concrete products manufacturer.

Below are some of the products available to enhance concrete placement, performance, and long-term durability.

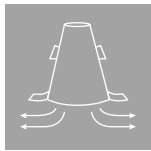

SIKA® VISCOCRETE® REDUCERS - WATER REDUCERS

The use of a water-reducing admixture provides a way to increase the overall strength, lower permeability, allow for easier placement and to control slump life for optimal surface finishing.

- Increase overall strength
- Lower permeability
- Ease of placement

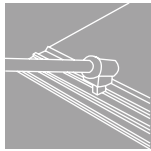

SIKA® VISCOFLOW® SERIES - WORKABILITY RETAINERS

Sika provides the newest admixture technologies to extend slump life and enable optimized pumping. Sika® ViscoFlow® technology extends slump life without retardation. For concrete pumping, the use of a viscosity modifier increases mix stability and segregation resistance resulting in better flow and improved surface quality/aesthetics.

- Increase slump life
- Extended working time
- Improve surface quality
- Decrease segregation

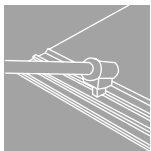

SIKA® STABILIZER-4R

Sika® Stabilizer-4R is a ready to use liquid-based viscosity modifying admixture. Sika® Stabilizer-4R improves stability and segregation resistance of concrete mixes without significant reduction of slump or flow, resulting in improved surface quality and aesthetics.

- Enhances stability of concrete matrix integrity during high slump placements
- Reduces segregation and bleeding
- Improves surface finishability
- Increases cohesiveness of lean and harsh mix designs

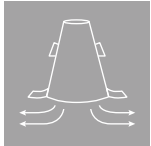

SIKA® PERFIN SERIES

Sika® PerFin-305 significantly improves quality of the concrete surface. The amount of pinholes, open pores, and other surface defects are reduced when Sika® PerFin-305 is utilized in concrete mixes.

- Concrete with minimal surface defects
- Improved aesthetics and uniformity of concrete surfaces
- Improved concrete smoothness
- Reduced labor needed for surface patching

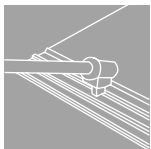

SIKACRETE® M-100

Sikacrete® M-100 is recommended for all high performance, high strength concrete and cementitious applications. Due to its cream white color, Sikacrete® M-100 is also suitable to produce colored concrete and architectural precast concrete products.

- Increased early and later age strengths
- Reduced permeability
- Improved concrete performance in freeze thaw conditions
- Produces lighter color concrete due to its creamy white color

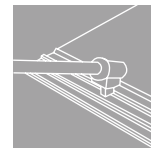

SIKA® RUGASOL®

Sika Rugasol® S is a spray applied, water soluble liquid, formulated to retard the set of surface mortar in concrete to enable the aggregate to be exposed. Sika® Rugasol® S is green in color to allow easy identification of areas where it has been applied and ensure a uniform coating is obtained.

- Architectural quality, uniform appearance with original color and texture of aggregate without sandblasting
- No danger of acid residue from strong washing compounds
- Easy to apply, less supervision of field personnel, no expensive equipment required

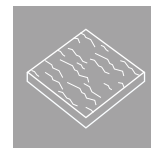

SHRINKAGE

The use of a shrinkage reducing admixture (SRA) or shrinkage reducing and compensating admixture (SRCA) helps to control early age shrinkage cracking in concrete. By reducing incidence of cracking from the moment of placement onward, life span is increased and repair costs reduced.

- Reduced shrinkage cracking
- Increase life span
- Lower repair costs

COLORED CONCRETE

Sika® Decorative Concrete color is the ideal way to add color to concrete that is to be patterned or textured with Sika® Greenstreak® Formliners. As the manufacturer of two of the most trusted and dependable brands of decorative concrete; Scofield and Butterfield Color; Sika Decorative Concrete brings a legacy of color engineering and performance that is unmatched by any other company.

INTEGRAL COLOR

The primary color system for Sika formliners is **SIKA INTEGRAL COLOR**. Integral color is added into the concrete mix, and then poured into the formwork, resulting in concrete formwork that is colored all the way through. It can be used alone, or in conjunction with Sika Concrete Stains to create a variety of appearances.

Products include: CHROMIX® Admixtures for Color-Conditioned® Concrete, SCOFIELD® Integral Color SG, Uni-Mix® Integral Concrete Colorant, Select Grade® Integral Concrete Colorant.



POST-APPLIED FINISHES | CONCRETE STAINS

For the most realistic appearance, giving the shadings of natural stones, use a post-applied color such as **SIKA CONCRETE STAIN**. These color finishes are typically sprayed onto the surface of the cured concrete, and sometimes applied by hand for detailed effects. Sika Concrete Stains are generally divided into two types: acid stain and water-based stain.

Concrete formwork that is colored with acid stain can have a variegated appearance, and the color is permanent. Available in a limited palette of browns, greens, and blacks, acid stain chemically reacts with the concrete and becomes part of the concrete surface. Due to the controlled mix design and newness of the concrete, acid stain will deliver a fairly consistent appearance to concrete formwork.

Products include: LITHOCHROME® Chemstain® Classic, Sierra Stain® Reactive Acid Stain.



An alternative to acid stains are **WATER-BASED STAINS**. These environmentally-friendly, high-performance, low-odor stains offer more color selections than acid stain, including vibrant reds, purples, yellows, and blues.

Products include: LITHOCHROME® Tintura Stain, Elements® Transparent Concrete Stain.



INSTALLATION GUIDE AND SPECIFICATION DATA

Sika thermoformed plastic formliners are used for texturing tilt-up, cast-in-place, or precast architectural concrete. Sheets of formliner attach to the formwork or casting bed prior to placing the concrete. Following placement and normal curing time, the formwork and formliner are stripped, leaving a textured concrete surface.

- Sika formliners are rigid thermoformed polymer alloy sheets, engineered to be lightweight and prioritize ease of handling at the job site.
- More than 80 standard patterns are available. Custom designs will be considered. Call Sika St. Louis with specific details.
- All patterns are available in at least two use ranges (use ranges explained, page 6).
- Sika UNI-CAST®, MULTI-CAST®, and DURA-CAST® formliners are interchangeable on the same job. Allowances need to be made for thickness differences between formliner grades.
- Formliner sheets are trimmed straight and square to a nominal 4' x 10' size (see catalog for actual dimensions, formliner size cannot exceed nominal 4' x 10'. Form pressures greater than 1000 lb/ft² may deform some of the deeper patterns. Contact Sika St. Louis for specific recommendations.)
- All Sika formliners have a hard void free surface that makes the formliner easy to strip, and does not absorb moisture or cause discoloration.

TYPICAL APPLICATIONS

- Residential/commercial buildings
- Water/waste water treatment plants
- Prisons
- Schools
- Airports
- Parking garages
- Exposed foundations
- Bridges
- Retaining walls
- Soundwalls
- Planters
- Corporate signs



INSTALLATION GUIDELINES

GENERAL

- Sika requires a full-scale pre-construction mockup to test specific concrete mix, slump, placement rates, form pressures, joint sealing, vibrating, and form stripping practices. The mockup must duplicate the materials, methods, workmanship, placement rates, and form pressures that will actually be used on the job. Failure to complete the preconstruction mockup will void all warranties.
- Formliners are shipped covered and banded to 4' x 10' skids. Although all Sika formliner materials are UV stabilized, the formliners should be covered if stored outside on the job site for long periods of time.
- At temperatures below 25°F, the formliner will become more rigid and will lose impact strength. Use extra care under these conditions.
- Concrete temperatures in excess of 140°F will adversely affect the material properties of the formliners. Sika does not recommend the use of formliners in these applications.

TRIMMING

- Formliners will need to be custom trimmed to fit the formwork on many jobs.
- A sturdy worktable should be built and outfitted with an edge guide running the 10' direction and an adjustable saw guide or rip fence.
- A circular handsaw with a fine tooth panel blade and a rip fence or saw guide is recommended. In most cases, use of a table saw will be difficult to achieve a straight cut.
- A carbide tipped blade with 40 or more teeth set at the depth appropriate to pattern is suggested. A sharp utility knife works well for trimming lighter gauge formliners; score the material and snap off the excess.
- If a formliner butts against a chamfer or reveal strip, miter the edge of the formliner on the same angle for proper fit.

SECURING TO FORMS

- Keep vertical joints plumb and on the same line. Horizontal joints should be kept level and in line at the same elevation.
- Rustication or reveal strips are recommended at formliner joints that do not blend with the pattern. A properly sized rustication will complement the pattern and can enhance the overall appearance of the concrete.
- When securing the formliner to forms, make sure that the correct side of the formliner goes toward the formwork. All Sika formliners have a tag indicating the form work side.
- Formliners will expand with an increase in temperature and will shrink when the temperature drops. As a rule of thumb, the formliner will change 1/16" in 10ft. with a 10°F change in temperature. Proper fastening minimizes formliner movement. The formliner may "grow" with large increases in

temperature. A fine spray of water on the formliner prior to placing the concrete will cause it to shrink to its original size. When possible, the formliner should be fastened during the warmest part of the day.

- Screws or nails should be placed on 12" to 24" centers that are evenly distributed over the sheet. Outer fasteners should be placed within 2" of the formliner edge. Attachment points should be random; a consistent pattern may appear obvious in the finished concrete. Placing fasteners at the peak of the formliner (valley of the concrete) will help hide fastener marks; however, this practice is not generally recommended. Placing fasteners at the valley of the formliner (concrete peak) is more practical and keeps the formliner more secure. Patterns with more relief and texture require more fasteners. More nails are required than screws since screws have more holding power. Use as few fasteners as possible for UNI-CAST® formliners to keep the formliner positioned.
- Screws: Easy to use, screws have the best holding power and are easily removed. Bugle head self-drilling and tapping screws #8-18 x 1" are the minimum size recommended. Self-drilling and tapping, the flat head fits flush with the formliner and may be used for steel or wood forms. A screw gun with adjustable torque setting is also recommended.
- Nails: Easy to install, nails feature good holding power. 7D or larger cement coated or ring shanked nails are recommended. A pneumatic nailer should be used with a pressure regulator.
- Staples: Small staples (approx. 1/8" wide x 3/8" deep) are easy to use and easily hidden in the pattern. They have much less holding power and should be used on 6" - 12" centers. Use a pneumatic stapler with pressure regulator.
- Pop rivets: Feature good holding power on metal forms but require more work than self-drilling screws.
- Wooden Dowels: On tilt-up or precast jobs where the formliner is attached to the concrete casting bed, screw or nail the formliner to 1/2" wooden dowels inserted in the concrete. The dowels are easy to drill out and patch when the job is complete.
- Construction Adhesive: On tilt-up concrete applications, construction adhesive may be used to adhere formliners to concrete slabs. The concrete and the formliner must be clean and dry during installation. After initial installation, keep the concrete surface dry, as moisture between the plastic and the concrete can break the adhesive bond. Sealing at the formliner joints will aid in maintaining this bond.
- Double-Coated Foam Tape: On tilt-up concrete applications, double-coated foam tape provides an easy way to secure the formliner to the casting bed. On most patterns, the tape should be centered on the formliner seams. Carpet tape 1/32" - 1/16" is recommended. Both formliner and concrete must be clean and dry.
- Backup Strips: To prevent deflection from the pressure of freshly placed concrete, some formliner patterns will require additional support. Generally, patterns with ribs wider than 1 1/2", or a depth of 1 1/2" or greater should have back-up strips installed (see Sika literature for recommendations). The need for back-up strips should be confirmed from the mockup. Wood or styrene foam insulation board may be effective back-up strip materials.

SEALING

- All formliner joints and tie holes should be sealed to prevent localized water loss and subsequent discoloration of the concrete. Grout leakage will make stripping difficult and may damage the formliner.
- Neutral cure silicone sealant is recommended for cast-in-place concrete. Once cured, it is flexible, has good adhesion, and won't discolor or stick to the concrete.

FORM BOLTS, TIES, AND BAR SUPPORTS

- Tie spacing should be a multiple of the formliner pattern repeat.
- Tight fitting holes may be drilled or cut with a hole saw.
- Reinforced fiberglass rod ties work well with architectural formliners. After stripping, the rods are snapped off and ground flush with the concrete. Patching and filling of holes is eliminated.
- Ties located in the "valley" of the concrete may be less obvious. Patching tie holes located in the "peak" of the concrete is easier.
- Bar supports or spacers should always rest against the portion of the formliner that is in contact with the formwork. The leg spacing of the bar supports should match the pattern repeat of the formliner.
- Supports and spacers should be plastic or plastic tipped to minimize rust stains on the finished concrete.
- Some deeper patterns may deform when walked on in precast and tilt-up applications. When placing the rebar mat, workers should walk on strips of 1/4" plywood to distribute the load on the formliner. The thin plywood strips are flexible enough to pull out through the rebar mat prior to concrete placement. The concrete itself distributes the load during placement. If permissible, walk on the reinforcing steel rather than the formliner surface.

RELEASE AGENTS

- Sika® Formliners are made from rigid, non-absorbing materials that will not bond to concrete.
- Formliners should be prepared with Sika® Form Release 8000 just prior to concrete placement. Proper use of Sika® Form Release 8000 will aid in stripping of forms, improve the surface appearance of the concrete, and speed clean-up between concrete placements. Other form release agents may cause cracking and degradation of the formliner material with subsequent failure. Although Sika UNI-CAST® single-use formliners do not require the use of a form release agent, it is still suggested to improve the surface appearance of the concrete.
- Apply form release agent at recommended rates. Over-application may produce surface voids.

CONCRETE MIX DESIGN

- For uniformity of color and texture, use one concrete supplier, making sure that all concrete materials come from the same sources.
- Recommended slump is 4 to 6 inches. Higher slump improves concrete consolidation in pattern details.

- Avoid overly sandy or high air-entrained mixes, as they tend to be “sticky” and can promote bug holes.
- For ribbed textures, coarse aggregate size should be smaller than the width of the rib. Oversize aggregates can cause honeycombing and brittleness of the concrete ribs.
- Use an elephant trunk or tremie during concrete placement to minimize aggregate segregation. Dropping fresh concrete long distances directly against the formliner may cause surface abrasion or deformation of the formliner pattern, resulting in an undesirable concrete appearance.
- Pumping concrete into the forms from the bottom of a wall will generally reduce air voids in the surface of the concrete. This method will also raise the form pressures significantly, which may damage the formliner.
- Proper use of a water reducing admixture (plasticizer) in the concrete mix will minimize air voids. Concrete placement rate may have to be reduced to keep form pressures at an acceptable level.
- High concentrate placement rates may create excessive form pressures, which can deform or damage the formliner. High concrete placement rates may also cause excessive air voids.
- Concrete lifts should not exceed 24 inches. Thoroughly vibrate concrete to achieve good consolidation, eliminate lift lines, and to minimize air voids. External vibrators can loosen the formliner from the formwork; internal vibrators are normally used. Contact between the vibrator and the formliner may damage the formliner. Under and over vibration may also cause defects in the surface of the concrete.
- Footprints, standing water, and dirt/debris should be removed from the formliner before placing concrete for precast and tilt-up concrete applications.
- Elevated temperatures encountered with heated curing beds may harm the formliner. Contact Sika (St. Louis Sales Office) for specific recommendations.

STRIPPING AND CLEAN-UP

- The force required in stripping forms with formliners is greater than smooth formwork. When applying the extra force needed, care should be taken so that the textured surface is not damaged.
- Formwork should be broken back after a minimum of 12 hours and removed preferably within 24 hours of concrete placement. Extending the time from placement to stripping can increase the force required.
- Begin stripping at the top of the formwork. Separate the form from the concrete slightly. Hold in this position for several minutes to allow the induced stress in the form to diminish. Continue to separate the formwork from the concrete in stages until final separation is achieved.
- Sika® Formliners are easily cleaned with household detergent and a stiff brush.

FINAL FINISHING

- Rubbing: Seams and forming defects may be removed with a stone while the concrete is green.
- Sandblasting: Many jobs call for sandblasting to roughen the surface and expose aggregate color. Sandblasting may also hide seams and forming defects but will not hide discoloration caused by grout leakage.

- **Patching:** When patching tie holes or more serious forming defects, a close color match is critical. Use the same materials used in the original mix and perform several trial runs before beginning work on the structure. If in doubt, hire a consultant. Bad patches look worse than the original problem.

AVAILABILITY AND COST

- **Availability:** Sika® Formliners are distributed worldwide through an extensive network of concrete forming and accessory dealers. Contact Sika (St. Louis Sales Office) for the nearest product dealer.
- **Lead Time:** Lead times will vary with order quantity, pattern, and production schedule. Some popular patterns are kept in stock for immediate delivery. Allow one-to-two weeks for most orders, and six weeks for custom patterns.
- **Price:** Price will vary with order quantity, pattern, and choice of UNI-CAST®, MULTI-CAST®, or DURA-CAST® grade.

TECHNICAL SERVICES

- Sika product engineers are available for consultation during design, specification, and product installation. Additional information, product brochures, 3-part CSI formatted specification, and technical notes are available upon request.

THE FOLLOWING ACI COMMITTEE REPORTS ARE RECOMMENDED:

ACI 117; "Specifications for Tolerances for Concrete Construction and Materials and Commentary"

ACI 301. Ch. 6; "Specifications for Structural Concrete"

ACI 303R; "Guide to Cast-in-Place Architectural Concrete Practice"

ACI 309 Ch. 7; "Guide for Consolidation of Concrete"

ACI 347 Ch. 5; "Guide to Formwork for Concrete"





TECHNICAL SERVICES

Sika distributors have the knowledge and ability to answer most questions. If additional information is needed, product brochures, specification sheets, and technical notes are available upon request. Sika engineers are available for consultation during design, specification, and product installation.

The following ACI Committee Reports are also recommended:

- ACI 117 “Specifications for Tolerances for Concrete Construction and Materials and Commentary”
- ACI 301; Ch. 6 “Specifications for Structural Concrete”
- ACI 303R “Guide to Cast-In-Place Architectural Concrete Practice”
- ACI 309; Ch. 7 “Guide for Consolidation of Concrete”
- ACI 347; Ch. 5 “Guide to Formwork for Concrete”

SUGGESTED PROPRIETARY SHORT FORM GUIDE SPECIFICATION

Textured architectural concrete surfaces as indicated in drawings and specifications to be formed using Sika® Architectural Formliner Pattern Number _____; as manufactured by Sika Corp. ; 3400 Tree Court Industrial Blvd., St. Louis, MO 63122; Phone 800-325-9504. Formliner mock-up, storage, handling, accessories, fabrication, preparation, and installation to comply with Sika® Greenstreak®’s written instructions and recommendations. Sika® shall provide a Job Site Guide with the above listed Formliner.

A long form, 3 part master specification in CSI format is available upon request. Although proprietary, the master specification includes reference and performance standards.

LIMITED WARRANTY

Sika warrants this product for one year from date of installation to be free from manufacturing defects and to meet the technical properties on the current Technical Data Sheet if used as directed within shelf life. User determines suitability of product for intended use and assumes all risks. Buyer’s sole remedy shall be limited to the purchase price or replacement of product exclusive of labor or cost of labor.

NO OTHER WARRANTIES EXPRESS OR IMPLIED SHALL APPLY INCLUDING ANY WARRANTY OF MERCHANTABILITY OR FITNESS FOR A PARTICULAR PURPOSE. SIKA® GREENSTREAK® SHALL NOT BE LIABLE UNDER ANY LEGAL THEORY FOR SPECIAL OR CONSEQUENTIAL DAMAGES. SIKA SHALL NOT BE RESPONSIBLE FOR THE USE OF THIS PRODUCT IN A MANNER TO INFRINGE ON ANY PATENT OR ANY OTHER INTELLECTUAL PROPERTY RIGHTS HELD BY OTHERS.

SIKA FULL RANGE SOLUTIONS FOR CONSTRUCTION:

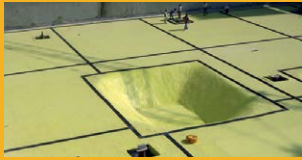

WATERPROOFING



CONCRETE



REFURBISHMENT



SEALING AND BONDING



FLOORING



ROOFING

All sales of Sika products are subject to Sika's current Terms and Conditions of Sale available at usa.sika.com or by calling 800-325-9504. Prior to each use of any Sika product, the user must always read and follow the warnings and instructions on the product's most current Product Data Sheet, product label and Safety Data Sheet, which are available at usa.sika.com or by calling Technical Services at 800-325-9504. Nothing contained in any Sika materials relieves the user of the obligation to read and follow the warnings and instructions for each Sika product as set forth in the current Product Data Sheet, product label and Safety Data Sheet prior to product use.

The sale of all Sika products are subject to the following Limited Warranty:

LIMITED MATERIAL WARRANTY

SIKA warrants this product for one year from date of installation to be free from manufacturing defects and to meet the technical properties on the current Product Data Sheet if used as directed within shelf life. User determines suitability of product for intended use and assumes all risks. Buyer's sole remedy shall be limited to the purchase price or replacement of product exclusive of labor or cost of labor.

NO OTHER WARRANTIES EXPRESS OR IMPLIED SHALL APPLY INCLUDING ANY WARRANTY OF MERCHANTABILITY OR FITNESS FOR A PARTICULAR PURPOSE. SIKA SHALL NOT BE LIABLE UNDER ANY LEGAL THEORY FOR SPECIAL OR CONSEQUENTIAL DAMAGES. SIKA SHALL NOT BE RESPONSIBLE FOR THE USE OF THIS PRODUCT IN A MANNER TO INFRINGE ON ANY PATENT OR ANY OTHER INTELLECTUAL PROPERTY RIGHTS HELD BY OTHERS.

Contact Sika:

Phone: 1.800.325.9504

Website: usa.sika.com

Our most current General Sales Conditions shall apply.

Please consult the Product Data Sheets prior to any use and processing.

Sika Corporation

3400 Tree Court Industrial Blvd.

St. Louis, MO 63122

Phone: 1.800.325.9504

BUILDING TRUST

